

ENCHUFES RÁPIDOS MULTIPRESA Y ADAPTADORES

ENCHUFES RÁPIDOS MULTIPRESA

Características técnicas

UN ÚNICO ENCHUFE PARA 4 TIPOS DE ADAPTADOR



Es un dato a remarcar que en el mercado existen varios tipos de adaptadores distintos, ya sea en la forma como en las dimensiones, que generalmente necesitan de enchufes específicos no intercambiables entre ellos.

Para solucionar este problema JENDER, propone una solución práctica y económica de intercambiabilidad con todos los adaptadores homologados en el mercado europeo, garantizando para todos una perfecta estanqueidad.

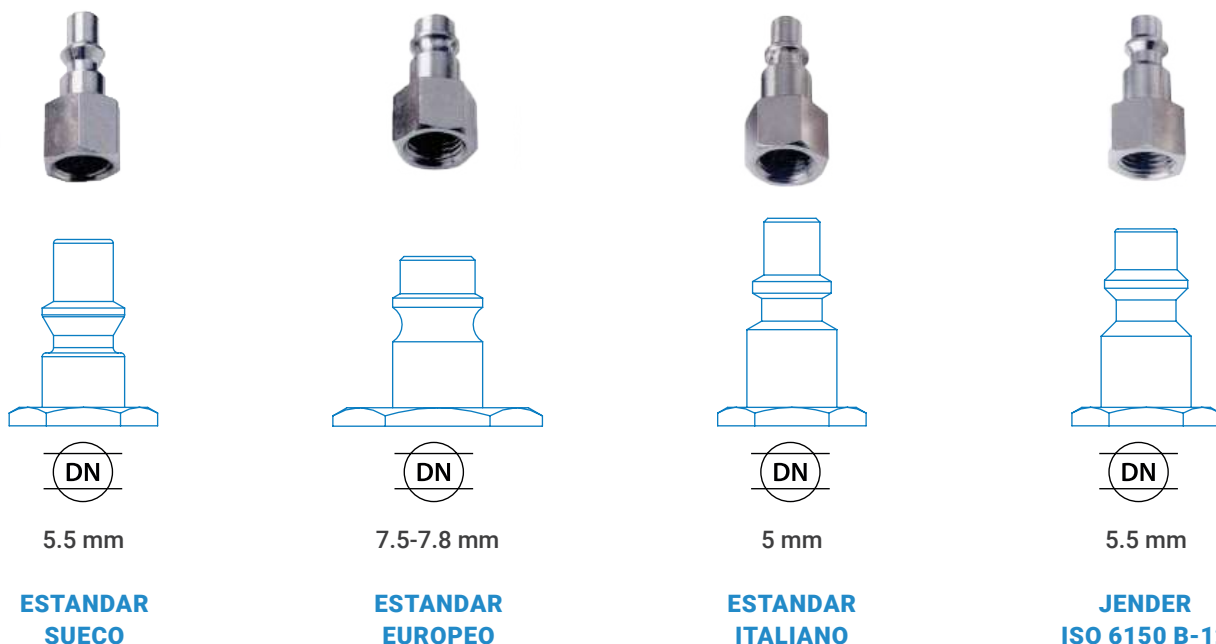

CARACTERÍSTICAS TÉCNICAS

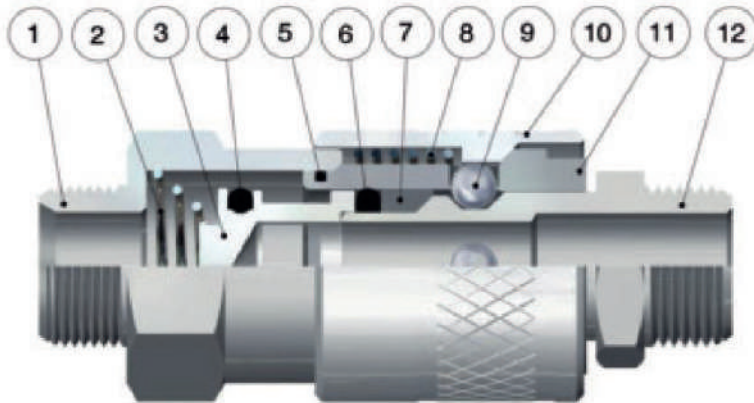

MATERIALES Y COMPONENTES:

1. Cuerpo en latón niquelado.
2. Esfera en acero AISI 420.
3. Anillo guía enchufe en latón niquelado.
4. Junta tórica en NBR.
5. Muelle tuerca en acero AISI 302.
6. Junta tórica en NBR.
7. Junta tórica en NBR.
8. Obturador en latón niquelado.
9. Muelle obturador en acero AISI 302.
10. Conexión terminal en latón niquelado.
11. Tuerca en latón niquelado.

1907/2006
REACH ✓

2011/65/C
RoHS ✓

PED
2014/68/UE

SIN
SILICONA



TEMPERATURA
-20°C / +80°C



FLUIDOS COMPATIBLES
Aire comprimido



**PRESIÓN ESTÁTICA MÁXIMA
(SIN PULSACIONES)**
35 bar



CAUDAL DE FLUJO
Adaptador: Jender
6 bar 1: 900
6 bar 0.5: 700
6 bar*: 1450
Escape libre*



ROSCAS
Gas cilíndrica
conforme ISO 228
Clase A

ADAPTADOR EN LATÓN NIQUELADO ISO 6150 B-12

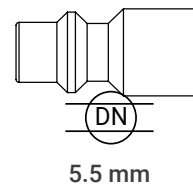

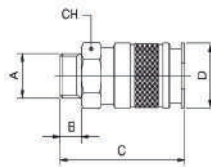

ENCHUFE RÁPIDO MULTIPRESA MACHO

CÓDIGO	A	B	C	D	CH
2351.891	1/4	8	49	24	21
2351.892	3/8	9	50	24	21
2351.893	1/2	10	51	24	24

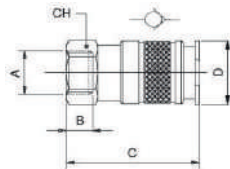

ENCHUFE RÁPIDO MULTIPRESA HEMBRA

CÓDIGO	A	B	C	D	CH
2351.894	1/4	11	51	24	21
2351.895	3/8	11.5	51	24	21
2351.896	1/2	14	55	24	24

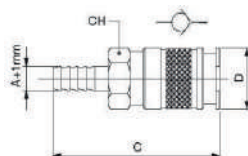

ENCHUFE MULTIPRESA ESPIGA

CÓDIGO	A	C	D	CH
2351.902	6	61	24	21
2351.903	8	61	24	21
2351.904	10	61	24	21
2351.905	12	61	24	21

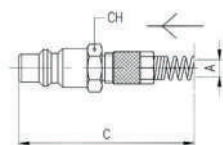

ENCHUFE MULTIPRESA TUBO MUELLE

CÓDIGO	A	C	D	CH
2351.982	6/4	138	24	21
2351.983	8/6	144.5	24	21
2351.984	10/6.5	153.5	24	21
2351.985	10/8	153.5	24	21
2351.986	12/10	159	24	21

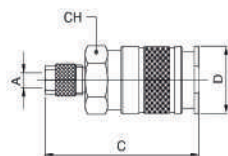

ENCHUFE MULTIPRESA TUBO

CÓDIGO	A	C	D	CH
2351.898	6/4	55	24	21
2351.899	8/6	55	24	21
2351.900	10/8	55	24	21
2351.901	12/10	57.5	24	21

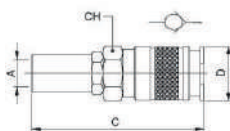

ENCHUFE MULTIPRESA TUBO PORTAGOMA

CÓDIGO	A	C	D	CH
2351.987	14/6	71	24	21
2351.988	17/8	71	24	21
2351.989	19/10	71	24	21

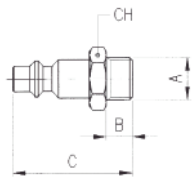
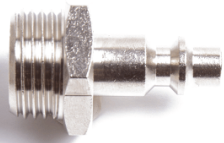

ADAPTADOR ESPIGA

CÓDIGO	A	B	C	CH
2351.972	1/4	8	36.5	17
2351.973	3/8	9	37.5	19
2351.974	1/2	10	39	24

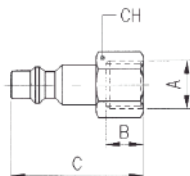
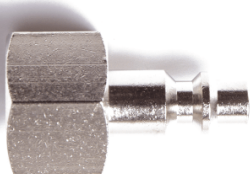

ADAPTADOR HEMBRA

CÓDIGO	A	B	C	CH
2351.975	1/4	11	36.5	17
2351.976	3/8	11.5	37	19
2351.977	1/2	14	39.5	24

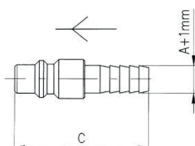

ADAPTADOR ESPIGA

CÓDIGO	A	C	D
2351.978	6	43.5	12
2351.979	8	43.5	12
2351.980	10	46	14
2351.981	12	46	16

